

Article number: 2031100M20201B3W

Description: E+G levelling foot
GN 31-100-M20-201-B3-W

Note: W With adjustable sleeve , Hygienic Version, Wrench flat at the bottom

Measures

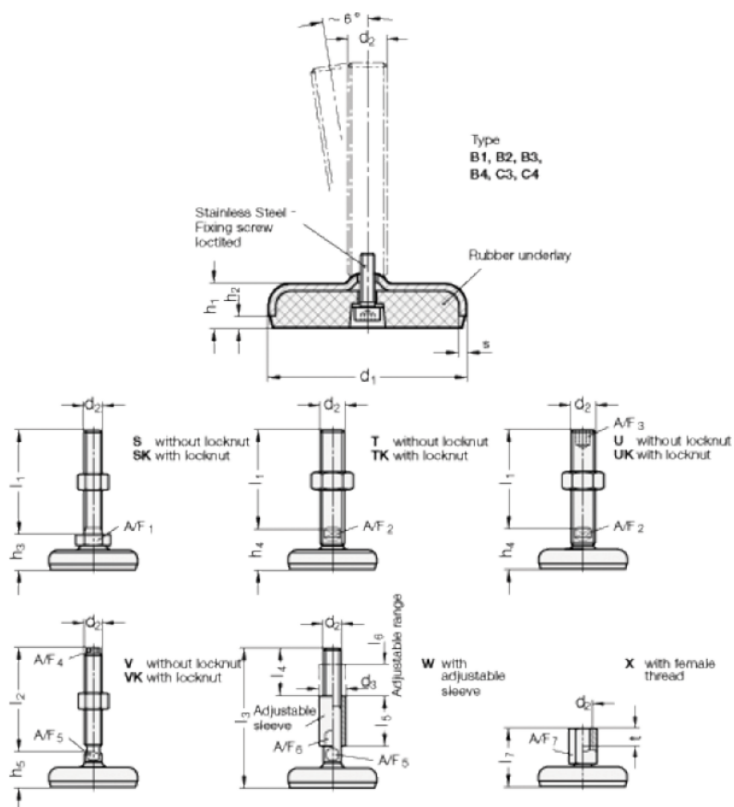

A/F5 = 16	I3 +4.0/0 = 201
A/F6 = 24	I4 = 56
d1 = 100	I5 = 56
d2 = 20	I6 = 36
d3 = 30	s = 3
h1 = 20	
h2 = 6	
I1 = 201	